

DH-HAC-HFW1230S

2MP Starlight HDCVI IR Bullet Camera

HDCVI



- Starlight
- Max. 30fps@1080P
- HD and SD output switchable
- 3.6mm fixed lens (2.8mm, 6mm optional)
- Max. IR length 30m, Smart IR
- IP67, DC12V



System Overview

Experience 1080P full HD video and the simplicity of using existing cabling infrastructure with HDCVI. The 1080P starlight HDCVI camera presents a high quality image with rich details even under extreme low-light conditions. Also, the Lite series features compact design and friendly price. It offers various motorized vari-focal/fixed lens models with a multi-language OSD and HD/SD switchable output. Its structural flexibility and high cost-performance makes the camera an ideal choice for SMB solutions.

Functions

4 Signals over 1 Coaxial Cable

HDCVI technology supports 4 signals to be transmitted over 1 coaxial cable simultaneously, i.e. video, audio*, data and power. Dual-way data transmission allows the HDCVI camera to interact with the XVR, such as sending control signal or triggering alarm. Moreover, HDCVI technology supports PoC for construction flexibility.

* Audio input is available for some models of HDCVI cameras.

Long Distance Transmission

HDCVI technology guarantees real-time transmission at long distance without any loss. It supports up to 800m(1080P)/1200m(720P) transmission via coaxial cable, and up to 300m(1080P)/450m(720P) via UTP cable.*

*Actual results verified by real-scene testing in Dahua's test laboratory.

Simplicity

HDCVI technology inherits the born feature of simplicity from traditional analog surveillance system, making itself a best choice for investment protection. HDCVI system can seamlessly upgrade the traditional analog system without replacing existing coaxial cabling. The plug and play approach enables full HD video surveillance without the hassle of configuring a network.

Starlight

With the adoption of high performance sensor, the camera is able to provide incomparable performance even under extreme lowlight environment. The starlight feature allows more details to be captured and accurate color to be recognized at night or in scenes with limited illumination.

Smart IR

The camera is designed with IR LED illumination for best lowlight performance. Smart IR is a technology to ensure brightness uniformity in B/W image under low illumination. Dahua's unique Smart IR adjusts to the intensity of camera's infrared LEDs to compensate for the distance of an object, and prevents IR LEDs from overexposing images as the object come closer to the camera.

Multi-formats

The camera supports multiple video formats including HDCVI, CVBS and other two common HD analog formats in the market. The four formats can be switched over through OSD menu or by PFM820(UTC controller). This feature makes the camera to be compatible with most end users' existing HD/SD DVRs.

Multi-language OSD

OSD menu provides multiple image adjustments and function settings to meet the requirements of different monitoring scenes. The OSD menu includes configurations such as backlight mode, day/night, white balance, privacy mask and motion detect. The camera supports 11 languages for OSD menu, namely, Chinese, English, French, German, Spanish, Portuguese, Italian, Japanese, Korean, Russian and Polish.

Protection

The camera's outstanding reliability is unsurpassed due to its rugged design. The camera is protected against water and dust with IP67 ranking, making it suitable for indoor or outdoor environments.

With working temperature range of -40 °C to +60 °C (-40 °F to +140 °F), the camera is designed for extreme temperature environments.

Supporting ±30% input voltage tolerance, this camera suits even the most unstable power supply conditions. Its 4KV lightning rating provides protection against the camera and its structure from the effects of lightning.

Technical Specification

Camera

Image Sensor	1/2.8" CMOS
Effective Pixels	1920(H)×1080(V), 2MP
Scanning System	Progressive
Electronic Shutter Speed	PAL: 1/25~1/100000s NTSC: 1/30~1/100000s
Minimum Illumination	0.005Lux/F1.6, 30IRE, 0Lux IR on
S/N Ratio	More than 65dB
IR Distance	Up to 30m (98feet)
IR On/Off Control	Auto / Manual
IR LEDs	18

Lens

Lens Type	Fixed lens / Fixed iris
Mount Type	Board-in
Focal Length	3.6mm (2.8mm, 6mm Optional)
Max Aperture	F1.6
Angle of View	H: 86.9° (106.0°/52.9°)
Focus Control	N/A
Close Focus Distance	1200mm (600mm/2400mm) 47.2" (23.6"/94.5")

DORI Distance

Note: The DORI distance is a "general proximity" of distance which makes it easy to pinpoint the right camera for your needs. The DORI distance is calculated based on sensor specification and lab test result according to EN 62676-4 which defines the criteria for Detect, Observe, Recognize and Identify respectively.

	DORI Definition	Distance
Detect	25px/m (8px/ft)	2.8mm: 39m(127ft) 3.6mm: 55m(181ft) 6mm: 83m(272ft)
Observe	63px/m (19px/ft)	2.8mm: 15m(51ft) 3.6mm: 22m(73ft) 6mm: 33m(109ft)
Recognize	125px/m (38px/ft)	2.8mm: 8m(25ft) 3.6mm: 11m(36ft) 6mm: 17m(54ft)
Identify	250ppm (76px/ft)	2.8mm: 4m(13ft) 3.6mm: 6m(18ft) 6mm: 8m(27ft)

Pan / Tilt / Rotation

Pan/Tilt/Rotation	Pan: 0° ~ 360° Tilt: 0° ~ 90° Rotation: 0° ~ 360°
-------------------	---

Video

Resolution	1080P (1920×1080)
Frame Rate	25/30fps@1080P, 25/30/50/60fps@720P

Video Output	1-channel BNC high definition video output / CVBS video output (Can switch)
Day/Night	Auto (ICR) / Manual
OSD Menu	Multi-language
BLC Mode	BLC / HLC / DWDR
WDR	DWDR
Gain Control	AGC
Noise Reduction	2D
White Balance	Auto / Manual
Smart IR	Auto / Manual

Certifications

Certifications	CE (EN55032, EN55024, EN50130-4) FCC (CFR 47 FCC Part 15 subpartB, ANSI C63.4-2014) UL (UL60950-1+CAN/CSA C22.2 No.60950-1)
----------------	---

Interface

Audio Interface	N/A
-----------------	-----

Electrical

Power Supply	12V DC ±30%
Power Consumption	Max 4.5W (12V DC, IR on)

Environmental

Operating Conditions	-40°C ~ +60°C (-40°F ~ +140°F) / Less than 90% RH * Start up should be done at above -40°C (-40°F)
Storage Conditions	-40°C ~ +60°C (-40°F ~ +140°F) / Less than 90% RH
Ingress Protection & Vandal Resistance	IP67

Construction

Casing	Aluminium
Dimensions	164.7mm×70mm×71.6mm (6.48"×2.76"×2.82")
Net Weight	0.36kg (0.79lb)
Gross Weight	0.45kg (0.99lb)

Ordering Information		
Type	Part Number	Description
2MP Camera	DH-HAC-HFW1230SP 2.8mm	2MP Starlight HDCVI IR Bullet Camera, PAL
	DH-HAC-HFW1230SP 3.6mm	
	DH-HAC-HFW1230SP 6mm	
	DH-HAC-HFW1230SN 2.8mm	2MP Starlight HDCVI IR Bullet Camera, NTSC
	DH-HAC-HFW1230SN 3.6mm	
	DH-HAC-HFW1230SN 6mm	
Accessories	PFA134	Junction box (For use alone or with PFA152-E pole mount)
	PFA152-E	Pole mount (For use with PFA134 junction box)
	PFM820	UTC Controller
	PFM800-E	Passive HDCVI Balun
	PFM800-4K	Passive Video Balun
	PFM800B-4K	Passive Video Balun
	PFM321	12V 1A Power Adapter
	PFM320D-015	12V 1.5A Power Adapter
	PFM300	12V 2A Power Adapter

Accessories

Optional:

		
PFA134 Junction box	PFA152-E Pole mount	PFM820 UTC Controller
		
PFM800-E Passive HDCVI Balun	PFM800-4K Passive Video Balun	PFM800B-4K Passive Video Balun
		
PFM321 12V 1A Power Adapter	PFM320D-015 Power Adapter	PFM300 Power Adapter

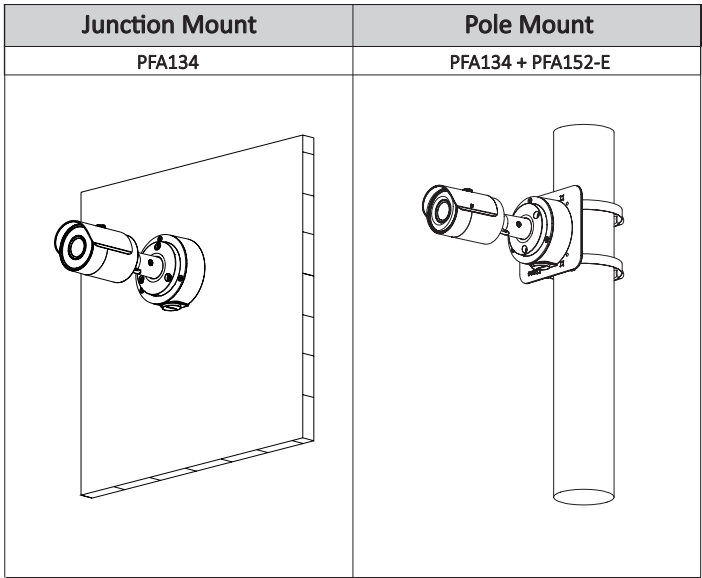

Dimensions (mm/inch)

